

# Veriton 7600 series User's guide

Copyright © 2003 Acer Incorporated  
All Rights Reserved.

Veriton 7600 series  
User's guide

Original Issue April 2003

Changes may be made periodically to the information in this publication without obligation to notify any person of such revision or changes. Such changes will be incorporated in new editions of this manual or supplementary documents and publications. This company makes no representations or warranties, either expressed or implied, with respect to the contents hereof and specifically disclaims the implied warranties of merchantability or fitness for a particular purpose.

Record the model number, serial number, purchase date, and place of purchase information in the space provided below. The serial number and model number are recorded on the label affixed to your computer. All correspondence concerning your unit should include the serial number, model number, and purchase information.

No part of this publication may be reproduced, stored in a retrieval system, or transmitted, in any form or by any means, electronic, mechanical, photocopy, recording, or otherwise, without the prior written permission of Acer Incorporated.

Model Number : \_\_\_\_\_

Serial Number: \_\_\_\_\_

Purchase Date: \_\_\_\_\_

Place of Purchase: \_\_\_\_\_

Acer and the Acer Logo are registered trademarks of Acer Inc. Other company's product names or trademarks are used herein for identification purposes only and belong to their respective companies.

1 First things first	1
System specifications	3
Package contents	5
Accessing the user's guide	6
2 System tour	7
Features	10
Performance	10
Multimedia	10
Connectivity	10
Front panel	12
Rear panel	14
Keyboard	16
Programmable keys	17
Internet/Suspend keys	18
Multimedia keys	19
Volume control/Mute knob	20
Lock keys	21
Cursor keys	22
Windows keys	23
Function keys	24
Palm rest	24
Optical drive	25
Hard disk	28
3 Setting up your computer	29
Arranging a comfortable work area	32
Adjusting your chair	32
Positioning your PC	32
Positioning your monitor	33
Positioning your keyboard	33
Positioning your mouse	34
Connecting peripherals	35
Connecting your mouse	35
Connecting your keyboard	37
Connecting a monitor	39
Connecting the power cable	40
Turning on your computer	41
Turning off your computer	42
Connecting options	43

Connecting your printer	43
Connecting the modem (optional)	44
Connecting to the network	45
Connecting multimedia devices	46
Connecting USB devices	49
4 Upgrading your computer	51
Installation precautions	54
ESD precautions	54
Preinstallation instructions	54
Post-installation instructions	55
Opening your computer	56
To remove the side panel	56
To replace the side panel	57
Internal components	59
System boards	60
Mainboard layout	60
Audio board	64
Upgrading your computer	65
Installing additional memory	65
Replacing the hard disk	67
Installing an expansion card	69
5 System utilities	73
Acrobat Reader	77
Acer LANScope (optional)	78
Norton AntiVirus	79
NTI CD-Maker (for models with CD-RW)	81
PowerDVD (for models with DVD)	83
BIOS utility	84
Reinstalling programs	85
Recovering your system	86
Using Backup (Windows XP only)	90
Disk Defragmenter (Windows XP only)	91
6 Frequently asked questions	93
Frequently asked questions	96

Appendix A: Notices	99
Appendix B: Taking care of your computer	105
Important tips	106
Cleaning and servicing	106
Asking for technical assistance	107
Index	109



1 First things first

This chapter describes the system specifications and the contents of your computer package .



# System specifications

Component	Specification
Processor	<ul style="list-style-type: none"> <li>• Intel Pentium®4 1.8 - 3.6 GHz</li> <li>• Intel Celeron® 2.0 - 2.6 GHz</li> </ul>
System memory	Four SDRAM slots support a maximum of 4 GB dual-channel DDR memory
Chipset	<ul style="list-style-type: none"> <li>• Intel MCH 865G</li> <li>• Intel MCH 865PE</li> </ul>
Graphics	Intel MCH 865G on-die VGA card supporting: <ul style="list-style-type: none"> <li>• DVMT technology</li> <li>• Dual View</li> <li>• 1 optional VGA port on rear</li> </ul> Intel MCH 865PE supporting: <ul style="list-style-type: none"> <li>• Add-on VGA card</li> </ul>
Audio	AC97 Codec
LAN	Broadcom 5705 supporting 10/100/1000 MB connectivity
IDE	40 pin parallel ATA IDE slot
FDD	1.44 MB 3.5 inch floppy drive
PS2	<ul style="list-style-type: none"> <li>• PS2 keyboard port</li> <li>• PS2 mouse port</li> </ul>
USB	Six external USB 2.0 ports
Serial port	One serial port
Printer port	One parallel printer port
Debug	One 4 LED port
Thermal	Dynamic fan speed control

<b>Component</b>	<b>Specification</b>
Security	<ul style="list-style-type: none"> <li>• Chassis lock (Kensington compatible)</li> <li>• Chassis intrusion alarm</li> </ul>
Chassis	Three models: H80, H40, H34A
Wake system	Wake on LAN Wake on modem Mouse/keyboard
HDD	<ul style="list-style-type: none"> <li>• 5400 RPM: 40 - 100 GB</li> <li>• 7200 RPM: 40 GB, 80 GB, 120 GB</li> </ul>
Optical Drive	CD-ROM, CD-RW, DVD-ROM, or DVD/CD-RW combo
Operating system	<ul style="list-style-type: none"> <li>• Windows 2000</li> <li>• Windows XP Home</li> <li>• Windows XP Professional</li> <li>• Novell</li> <li>• SCO Unix</li> <li>• Red Hat Linux</li> </ul>
Dimensions	<ul style="list-style-type: none"> <li>• Mini-Tower 424(H) /200(W) /414(D)</li> <li>• Desktop 135(H) /380(W) /420(D)</li> <li>• Small Form Factor 95(H) /324(W) /399(D)</li> </ul>
Weight	<ul style="list-style-type: none"> <li>• Mini-Tower 8.5 kg</li> <li>• Desktop 6.5 kg</li> <li>• Small Form Factor 5.3 kg</li> </ul>
Thermal overrides	<ul style="list-style-type: none"> <li>• System temp &gt;90°C - functions suspended until system temp is below 90°C</li> <li>• CPU temp &gt;110°C - functions suspended until CPU temp is below 110°C</li> <li>• CPU temp &gt;120°C - system auto-shutdown</li> </ul>

# Package contents

Before you unpack your computer, make sure that you have enough space to set up your computer.

Carefully unpack the carton and remove the contents. If any of the following items are missing or damaged, contact your dealer immediately:

- Veriton 7600 series
- Items contained in the accessory box
  - USB or PS/2 keyboard
  - USB or PS/2 mouse
- User's guide and installation poster
- Other user documentation and third-party software

# Accessing the user's guide

This user's guide is also available on your computer as an Adobe Acrobat PDF file.

## To access the user's guide (for Windows XP)

- 1 On the Windows XP taskbar, click on the Start button then select Help and Support Center.
- 2 On the Help and Support Center home page, double-click the Veriton 7600 series Online icon.

## To access the user's guide (for Windows 2000)

- 1 Double-click on the Veriton 7600 series Online icon on your Windows desktop.

## 2 System tour



This chapter discusses the features and components of your computer.

# Features

Here are just a few of your computer's many features:

## Performance

- Intel Pentium® 4 supporting FSB up to 800 MHz  
or
- Intel Celeron CPU supporting FSB up to 400 MHz
- Intel Hyperthreading Technology supported on 3.06 GHz and higher Pentium® 4 systems
- Intel 865G/865PE ICH5 chipset
- DDR-SDRAM 400/333/266, 4 DIMM slots, Expandable to 4GB dual-channel memory
- Power management function
- 3.5-inch floppy drive
- CD-ROM, CD-RW, DVD-ROM, or DVD/CD-RW combo drive
- High-capacity, Enhanced-IDE hard disk
- Supports USB 2.0 high-performance peripherals

## Multimedia

- 3-D quality audio system via onboard audio controller
- Audio-in/Line-in, Audio-out/Line-out, Headphone-out, and Microphone-in interfaces



.....

**Note:** The system has two microphone-in jacks (front and rear). However, you can not use both of them at the same time. By default, your system enables the microphone-in jack in front and disables the one at the back.

## Connectivity

- Two PS/2 interfaces for mouse and keyboard
- One serial port









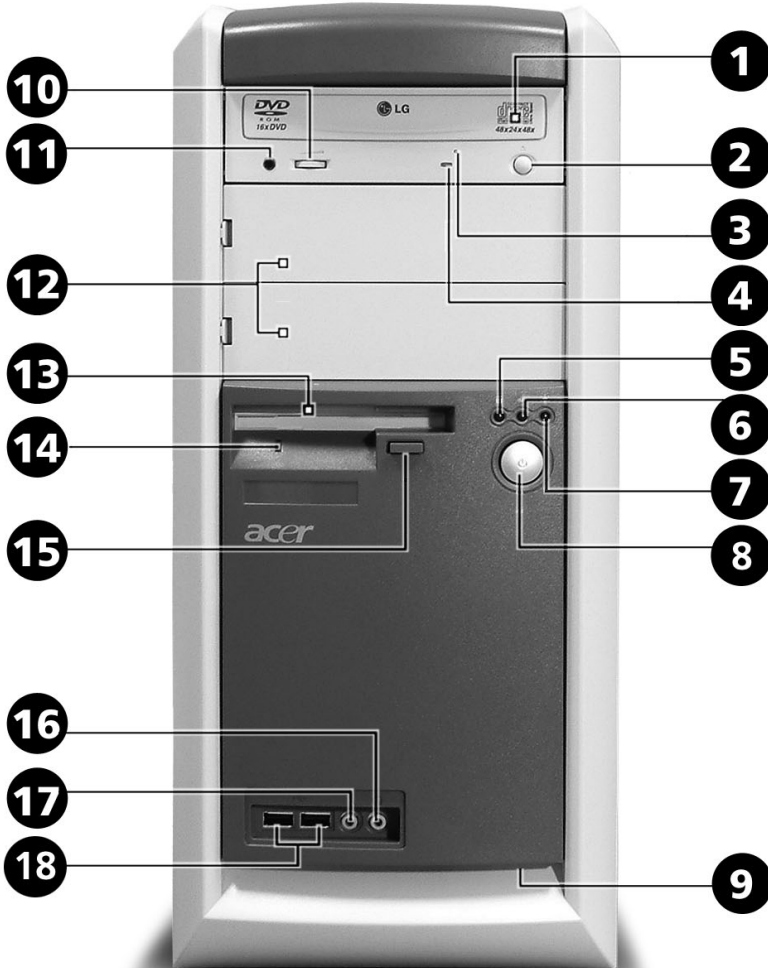

- One parallel port
- One VGA port
- Eight Universal Serial Bus (USB) 2.0 ports (two internal, two on the front and four on the rear panel)
- High-speed V92, 56K Fax/modem (optional)
- Broadcom 5705 10/100/1000Base-T Gigabit LAN support with remote wake-up function

# Front panel

Your computer's front panel consists of the following:



Label	Icon	Component
1		Optical drive tray
2		Stop/Eject button
3		Optical drive emergency eject slot
4		Optical drive activity light-emitting diode (LED)
5		Hard disk activity LED
6		LAN activity LED
7		Power LED
8		Power button
9		One touch recovery button (Optional)
10		Volume control
11		Optical drive Headphone/Earphone port
12		5.25-inch drive bays
13		3.5-inch floppy drive
14		Floppy drive LED
15		Floppy drive eject button
16		Speaker-out/Line-out port
17		Microphone-in jack (front) <small>see note</small>
18		USB ports









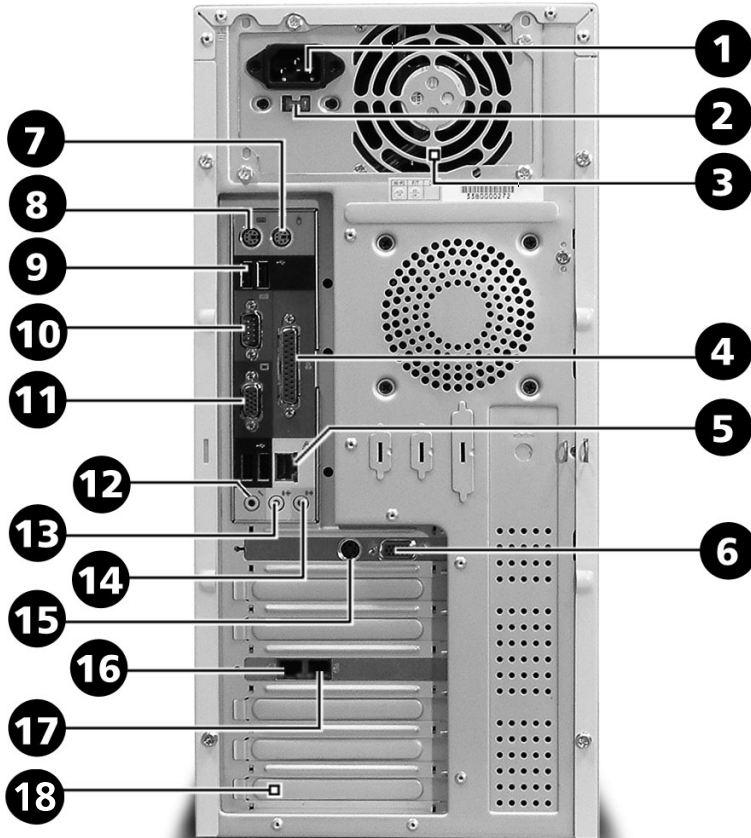





**Note:** The system has two microphone-in jacks (front and rear). However, you can not use both of them at the same time. By default, your system enables the microphone-in jack in front and disables the one at the back.

# Rear panel

Your computer's rear panel consists of the following:



Label	Icon	Color	Component
1			Power cord socket
2			Voltage selector switch
3			Power supply
4		Burgundy	Parallel/Printer port
5		White	Network port
6		Blue	CRT/LCD monitor port
7		Green	PS/2 mouse port
8		Purple	PS/2 keyboard port
9		Black	USB ports
10		Teal or Turquoise	Serial port
11		Blue	CRT/LCD monitor port
12		Pink	Microphone-in jack (rear)
13		Lime	Audio-out/Line-out jack
14		Light blue	Audio-in/Line-in jack
15			S-Video out port
16			Handset line port
17			Telephone line port
18			Expansion slots

For information on how to connect the peripherals, see page 35 and “Connecting options” on page 43.

# Keyboard

The keyboard has full-sized keys that include separate cursor keys, two Windows keys, and twelve function keys.

For information on how to connect your keyboard, see “Connecting your keyboard” on page 37.

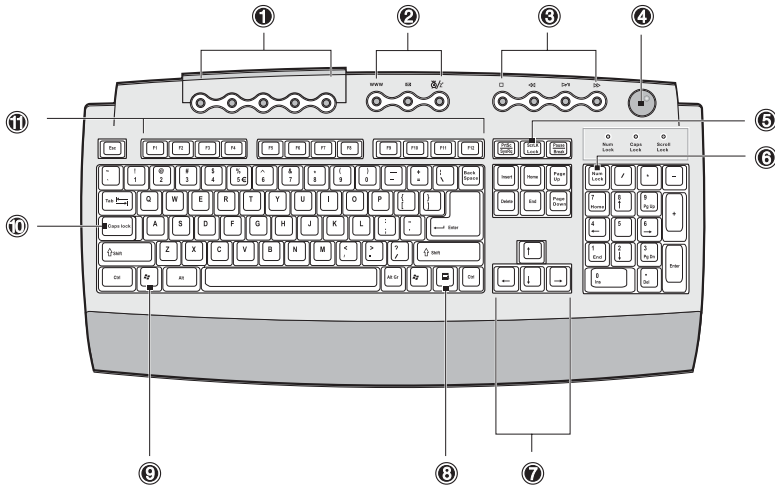

No.	Description
1	Programmable keys
2	Internet/Suspend keys
3	Multimedia keys
4	Volume control/Mute knob
5	Scroll lock key
6	Num lock key
7	Cursor keys

No.	Description
8	Application key
9	Windows logo key
10	Caps lock key
11	Function keys

## Programmable keys

The programmable keys help you directly access a URL (Web site) or launch any program, files, or application in your system. The fifth key is set to launch the Windows Media Player. If you want to configure the settings of each key, right click on the Magic Keyboard icon located on the desktop.

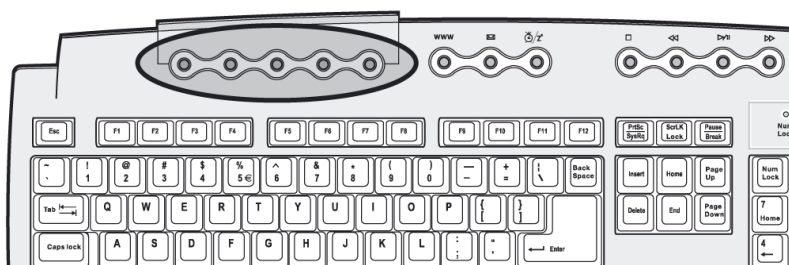

## Internet/Suspend keys

The Internet/Suspend keys consist of three buttons:

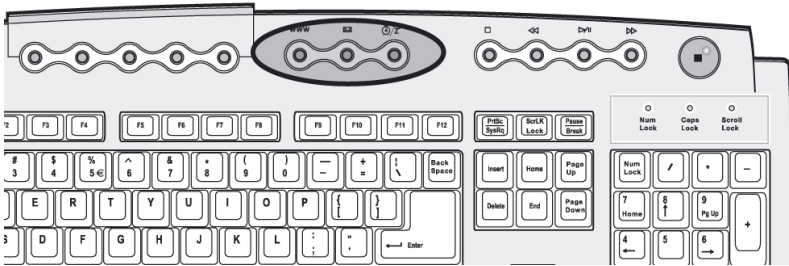

Icon	Key	Description
	Email	Launches your email application.
<b>WWW</b>	Web browser	Launches your current default browser.
<b>Z</b>	Suspend	Press this button to put system to sleep.



## Multimedia keys

Allow you to conveniently play, pause, stop, step forward, or step back a song or movie using your keyboard.

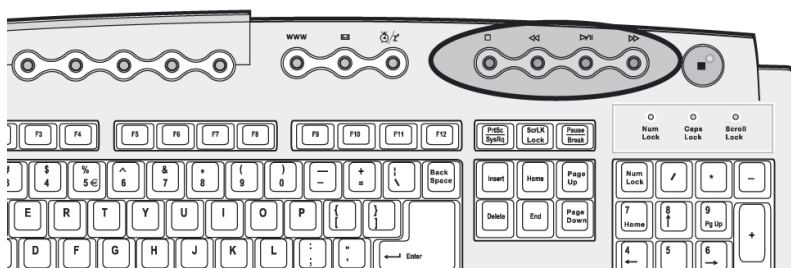

Icon	Key	Description
▶▶ /	Play/Pause	Press to start playing the audio track or video file. Press again to pause.
■	Stop	Press to stop playing the audio track or video file.
▶▶▶	Forward	Press to skip forward to the next track or video file and start playing.
◀◀◀	Backward	Press to skip backward to the previous track or video file and start playing.

## Volume control/Mute knob



The volume control/mute knob controls the speaker volume. Turn it clockwise or counterclockwise to adjust the volume. Press it to toggle between mute and sound.

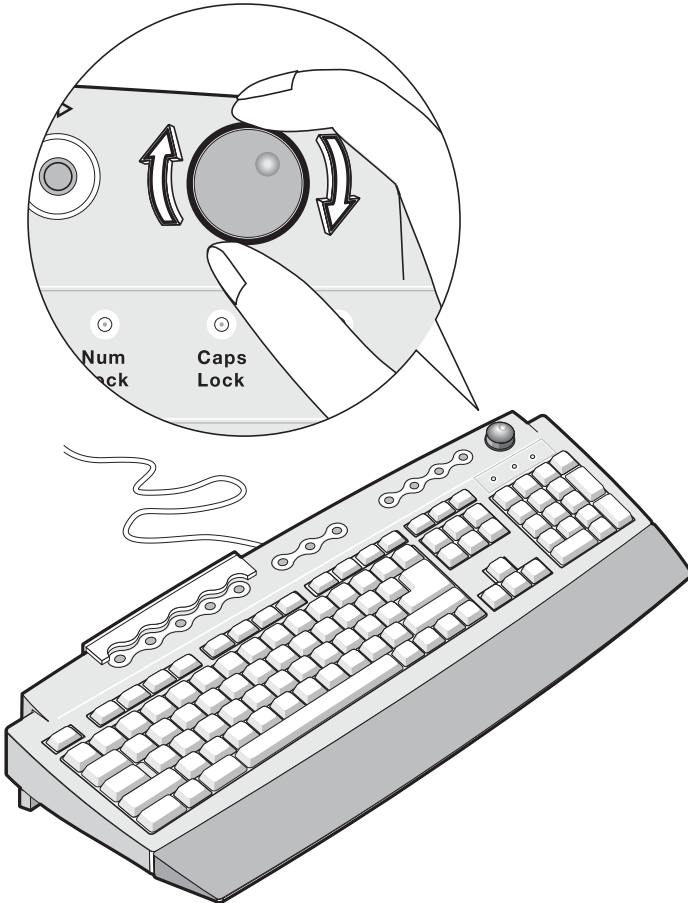

## Lock keys

The keyboard has three lock keys which you can toggle on and off to switch between two functions.

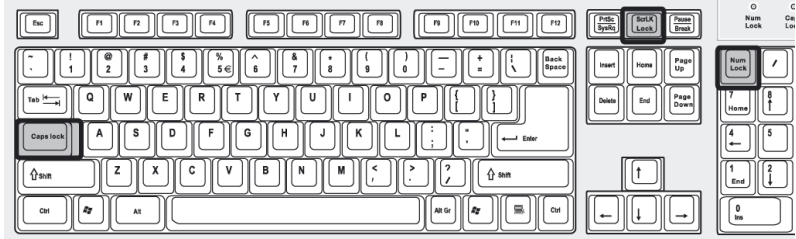

Lock key	Description
Caps Lock	When activated, all alphabetic characters typed appear in uppercase (same function as pressing Shift + <letter>).
Scroll Lock	When activated, the screen moves one line up or down when you press the up arrow or down arrow respectively. Take note that Scroll Lock may not work with some applications.
Num Lock	When activated, the keypad is set to numeric mode; i.e., the keys function as a calculator (complete with arithmetic operators such as +, -, * and /).

# Cursor keys

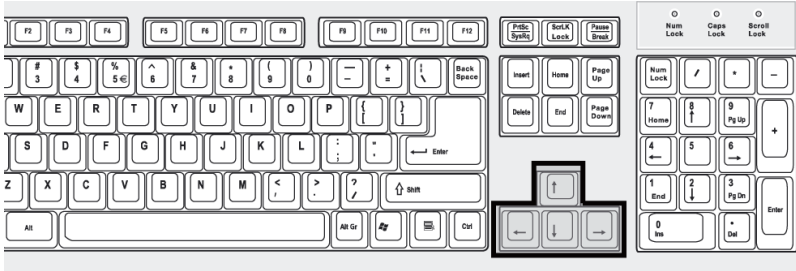

The cursor keys, also called the arrow keys, let you move the cursor around the screen. They serve the same function as the arrow keys on the numeric keypad when the Num Lock is toggled off.



## Windows keys

The keyboard has two keys that perform Windows-specific functions.



Key	Description
Windows logo key 	Start button. Combinations with this key perform special functions, such as: <ul style="list-style-type: none"> <li>• <b>Windows + Tab</b>: Activate the next Taskbar button</li> <li>• <b>Windows + E</b>: Explore My Computer</li> <li>• <b>Windows + F</b>: Find Document</li> <li>• <b>Windows + M</b>: Minimize All</li> <li>• <b>Shift + Windows + M</b>: Undo Minimize All</li> <li>• <b>Windows + R</b>: Display the Run dialog box</li> </ul>
Application key 	Opens the applications context menu (same function as clicking the right button of the mouse).

## Function keys

The function keys, F1 - F12, let you perform specific functions, depending on the application that uses them.

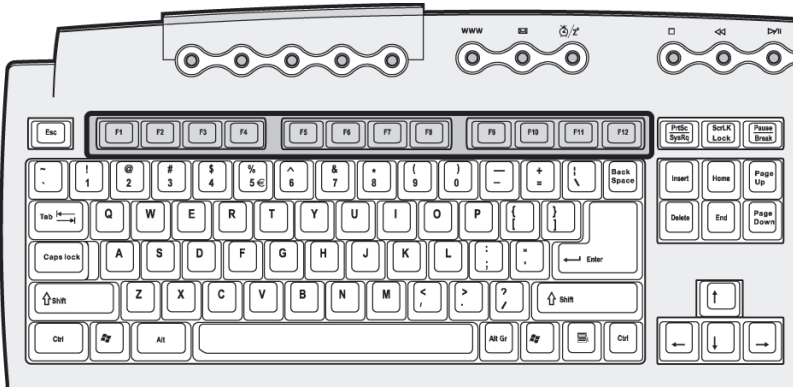

## Palm rest

The detachable palm rest provides you a comfortable place to rest your hands while typing.

# Optical drive

Your computer may come with a CD-ROM, DVD-ROM or a combo DVD/CD-RW drive. This drive is located on the front panel of your computer. The CD-ROM drive allows you to play different types of compact discs (CDs). The DVD-ROM drive allows you to play not only old CD-ROMs, CD-I discs, and video CDs, but digital video discs (DVDs) as well. DVD or DVD-ROM is a type of disc media that holds a minimum of 4.7-GB (gigabytes), enough for a full-length movie. The CD-RW drive allows you to record or burn CD-RW (recordable and rewritable) discs.

CDs and DVDs, like diskettes, are also compact, lightweight, and easy to carry around. However, they are more delicate than diskettes and must be handled with extra care.

To insert a CD or DVD into your computer's CD-ROM or DVD drive:

1. Gently push the Eject button located on the front panel.



2. When the disc tray slides open, place the CD or DVD gently on the tray. Make sure that the label or title side of the disc is facing upward. When holding a disc, hold it by the edges to avoid leaving smudges or fingerprints.



3. Push the eject button again to close the tray.

## To take care of your CDs and DVDs

- Keep your disc in its case when not in use to avoid scratches or other damage. Any kind of dirt or damage can affect the data on the disc, impair the disc lens reader on the CD or DVD drive, or stop the computer from successfully reading the disc.
- When handling discs, always hold them by the edges to avoid smudges or fingerprints.
- When cleaning discs, use a clean, dust-free cloth and wipe in a straight line from the center to the edge. Do not wipe in a circular motion.



- Clean your CD or DVD drive periodically. You may refer to the Cleaning kit for instructions. Cleaning kits can be purchased in any computer or electronics shop.

# Hard disk

Your computer is preinstalled with a high-capacity Enhanced-IDE (E-IDE) hard disk.

For instructions on how to upgrade or replace your hard disk, see “Replacing the hard disk” on page 67.

# 3 Setting up your computer



This chapter contains step-by-step instructions on how to set up your computer and connect additional peripherals.

## Arranging a comfortable work area

Working safely begins with the arrangement of your work space and the proper use of equipment. For this reason, it is very important to take time and think about how you are going to arrange your work area. Refer to the diagram on the following page as you set up your system.

Here are some points to consider:

### Adjusting your chair

Having the right kind of chair does not necessarily mean that you'll be properly supported. It is necessary to adjust your chair to fit your body. Proper body posture will make you more comfortable and productive.

- Avoid tilting your chair. If you have a chair that tilts, lock the tilt knobs so that your chair will not tilt forward or backward while you are using your computer.
- Adjust your chair height in such a way that you can sit on it with your thighs parallel to the floor and your feet resting flat on the floor.
- Rest your body on the chair back. Your torso works harder to maintain balance if you do not rest your body on the chair back.

### Positioning your PC

Take note of the following when selecting a location for your computer:

- Do not put your computer near any equipment that might cause electromagnetic or radio frequency interference such as radio transmitters, televisions, copy machines, or heating and air-conditioning equipment.
- Avoid dusty areas and extremes of temperature and humidity.
- You may place your computer beside your desk or under your table, as long as it does not block the space that you need for working and moving.

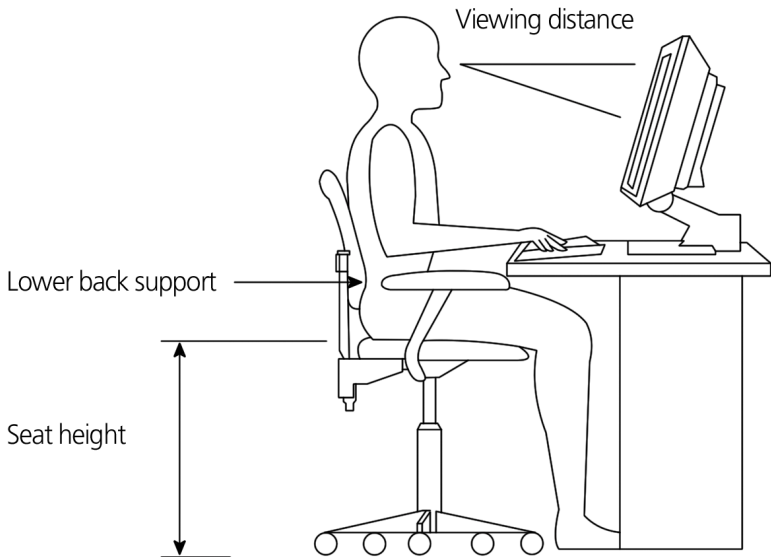

## Positioning your monitor

Place your monitor at a comfortable viewing distance, usually 50 to 60 centimeters away. Adjust the display in such a way that the top of the screen is at or slightly below eye level.

## Positioning your keyboard

The location of the keyboard is a very important factor to your posture. Placing it too far away will make your body lean forward forcing you to sit in an unnatural position. Placing it too high will add tension to your shoulder muscles.

- The keyboard should be placed just above your lap. Adjust the keyboard height by flipping the folding stands located under the keyboard.
- Keep your lower arms parallel to the floor as you type. Your upper arms and shoulders should be relaxed. Then try typing with a light

touch. If you feel any shoulder or neck strain, stop for a while and check your posture.

- Position your keyboard in front of your monitor. Putting your keyboard beside your monitor will make you turn your head while you type which could add tension to your neck muscles that may later result in neck strain.

## Positioning your mouse

- The mouse should be placed on the same surface as your keyboard so that you can reach it with ease.
- Adjust its position to allow enough space for movement without making you stretch or lean over.
- Use your arm to move the mouse. Do not rest your wrist on the table when moving the mouse.



# Connecting peripherals

Setting up your computer is easy. For the most part, you only have four things to connect: the mouse, the keyboard, the monitor, and the power cable.



.....

**Note:** The peripherals shown in the connections below are for your reference only. Actual device models may vary in select countries.

## Connecting your mouse

### USB mouse

Plug your USB mouse cable into any of the USB ports (black) located on the front and rear panels of your computer.



## PS/2 mouse

Plug the PS/2 mouse cable into the PS/2 mouse port  (green port) located on the rear panel of your computer.



## Connecting your keyboard

### USB keyboard

Plug your USB keyboard cable into any of the USB ports (black port) located on the front and rear panels of your computer.

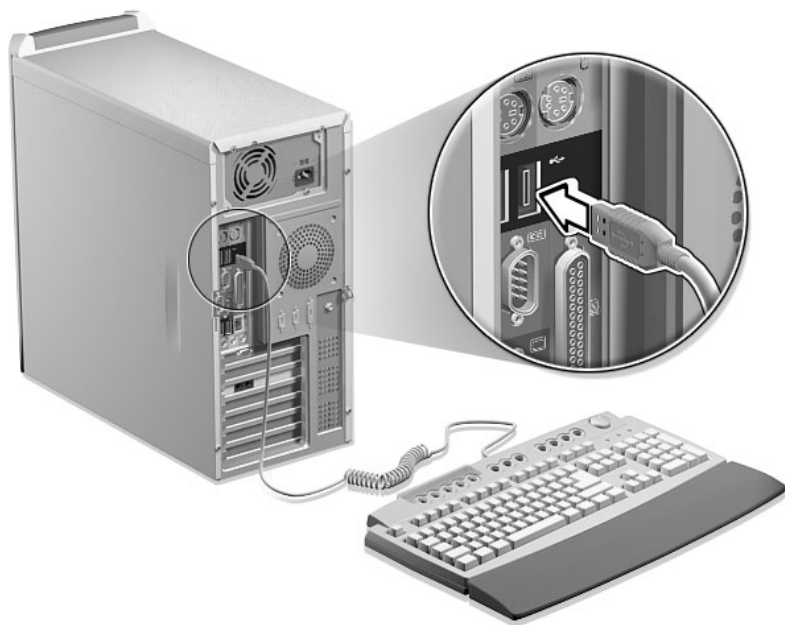

## PS/2 keyboard

Plug your PS/2 keyboard cable into the PS/2 keyboard port  (purple port) located on the rear panel of your computer.



## Connecting a monitor

To connect a monitor, simply plug the monitor cable into the monitor port  (blue port) located on the rear panel of your computer.



.....  
**Note:** Refer to the monitor manual for additional instructions and information.



## Connecting the power cable



**Caution:** Before you proceed, check the voltage range in your area. Make sure that it matches your computer's voltage setting. If they don't match, change your computer's voltage setting according to your area's voltage range.

Set the voltage selector switch to the voltage range applicable to your area (a). Plug the power cable into the power cable socket located on the rear panel of your computer (b). Then plug the other end of the power cable into a power outlet (c).



# Turning on your computer

After connecting the necessary peripherals and plugging in the power cable, you are now ready to turn the computer on and get to work.

To turn on your computer:

- 1 Turn on all peripherals connected to your computer such as the monitor, printer, fax, speakers, etc.
- 2 On the front panel of your computer, press the Power button.



**Important:** Make sure that the power cable is properly plugged into an electrical outlet. If you are using a power strip or an AVR (Auto-Voltage Regulator), make sure that it is plugged in and turned on.

# Turning off your computer

To turn off your computer, follow the steps below.

For Windows XP:

- 1 On the Windows XP taskbar, click on the Start button, and click Turn Off Computer; then click Turn Off.
- 2 Turn off all peripherals connected to your computer.

For Windows 2000:

- 1 On the Windows 2000 taskbar, click on the Start button, highlight Shut Down, select Shut down from the drop down window then click on OK.
- 2 Turn off all peripherals connected to your computer.

If you cannot shut down your computer normally, press the power button for at least four seconds. Quickly pressing the button may put the computer in Suspend mode only.



# Connecting options

## Connecting your printer

Your computer supports parallel, serial and USB printers.

To connect a parallel printer, plug the printer cable into the parallel port  (burgundy port) located on the rear panel of your computer.



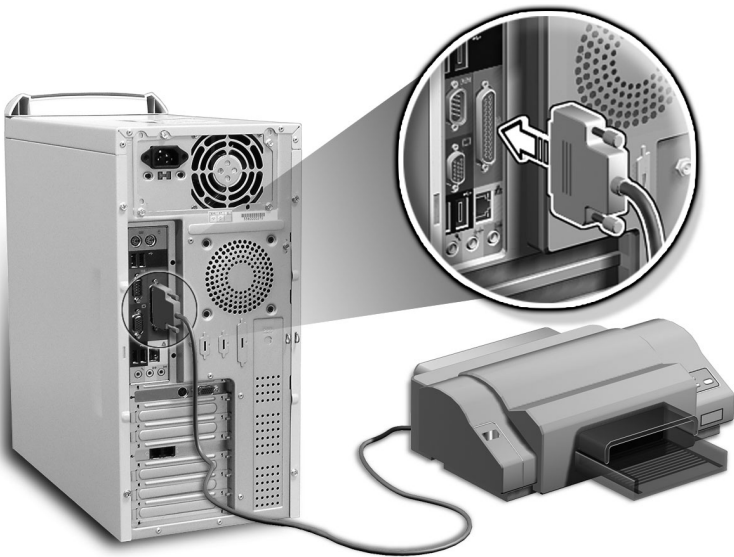

.....  
**Note:** The printer shown below is for your reference only. Actual device model may vary by country.



.....  
**Note:** If you are using a serial printer, connect the printer cable into the serial port located on the rear panel of your computer. In the same manner, connect a USB printer by plugging the printer cable into any of the USB ports located on the front and rear panel.

## Connecting the modem (optional)

Set up your modem connection by plugging the telephone line  and handset line  into their corresponding ports on the rear panel of your computer.



## Connecting to the network

You can connect your computer to a Local Area Network (LAN) using a network cable. To do so, simply plug the network cable into the network port  (white port) on the rear panel of your computer.

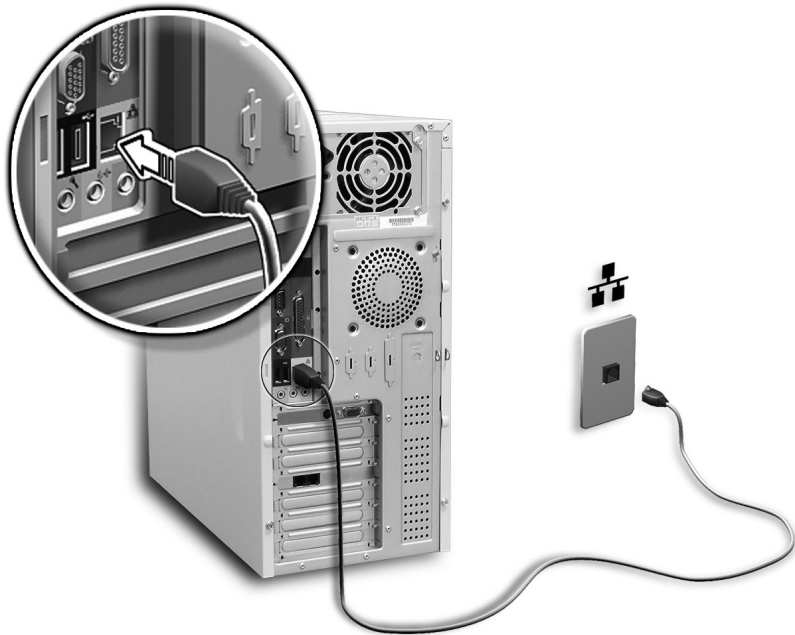

**Note:** Consult your network system administrator or operating system manual for information on how to configure your network setup.

## Connecting multimedia devices

You can connect multimedia devices such as microphone, earphone or headphone, external speakers, and audio line-in device. These devices will allow you to take advantage of your computer's multimedia features.



.....  
**Note:** The multimedia devices shown below are for your reference only. Actual device models may vary in select countries.

Plug the devices in as follows:



.....  
**Note:** For information on how to configure multimedia devices, consult the documentation that came with each device.

- microphone: connects to the Microphone-in jack  (pink jack) located on the front and rear panel of your computer.



.....  
**Note:** The system has two microphone-in jacks (front and rear). However, you can not use both of them at the same time. By default, your system enables the microphone-in jack in front and disables the one at the back.



- earphones, headphones: connect to the Headphone-out jack (lime jack) located on the front panel of your computer 



.....

**Note:** To adjust the volume of the headphones, click the Volume icon located on the taskbar at the bottom of your screen. When the volume control pops up, drag the Volume control lever to the desired level. You can also use the Volume control button on the keyboard.



- external speakers: connect to the Audio-out/Line-out jack (green jack) located on the rear panel of your computer.

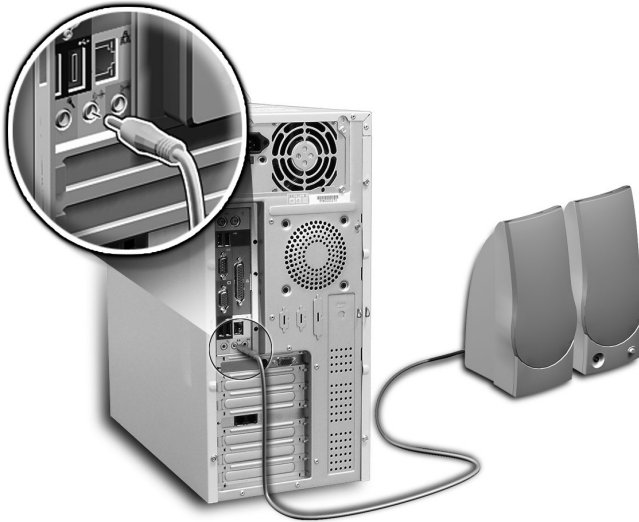

- audio line-in device: connects to the Audio-in/Line-in jack (light blue jack) located on the rear panel of your computer



## Connecting USB devices

Universal Serial Bus (USB) is a serial bus design that is capable of cascading peripherals such as a digital camera, keyboard, mouse, joystick, scanner, printer and modem. With USB, complex cable connections can be eliminated.

Your computer comes with six external USB ports: two on the front and another four on the rear panel. These ports support USB 2.0 high performance external devices such as webcams and digital still cameras. They also allow you to connect additional USB devices to your computer without using up its system resources.

To connect a USB device, simply plug the device cable into any of the USB ports  (black) located on the front and rear panels of your computer.



**Note:** The USB devices shown below are for your reference only. Actual device models may vary by geographic region.



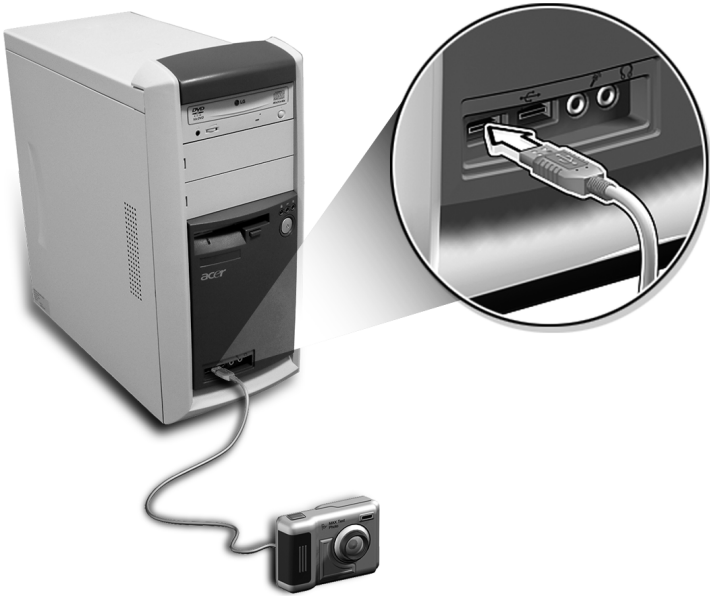

**Note:** Some USB devices have a built-in USB port which allows you to connect or daisy-chain more USB devices.



# 4 Upgrading your computer



This chapter contains instructions on how to upgrade your computer and basic information about your system boards that you will find helpful when performing the upgrade process.

# Installation precautions

Before you install any computer component, we recommend that you read the following sections. These sections contain important ESD precautions along with preinstallation and post-installation instructions.

## ESD precautions

Electrostatic discharge (ESD) can damage your processor, disk drives, expansion boards, and other components. Always observe the following precautions before you install a computer component:

- 1 Do not remove a component from its protective packaging until you are ready to install it.
- 2 Wear a wrist grounding strap and attach it to a metal part of the computer before handling components. If a wrist strap is not available, maintain contact with the computer throughout any procedure requiring ESD protection.

## Preinstallation instructions

Always observe the following before you install any component:

- 1 Turn off your computer and all the peripherals connected to it before opening it. Then unplug all cables from the power outlets.
- 2 Open your computer according to the instructions on page 56.
- 3 Follow the ESD precautions described above before handling a computer component.
- 4 Remove any expansion boards or peripherals that block access to the DIMM sockets or component connectors.
- 5 See the following sections for specific instructions on the component you wish to install.



.....  
**Warning! Not turning off the computer properly before you start installing the components may cause serious damage.**

**Do not attempt the procedures described in the following sections unless you are a qualified service technician.**

## Post-installation instructions

Observe the following after installing a computer component:

- 1 See to it that the components are installed according to the step-by-step instructions in their respective sections.
- 2 Replace any expansion boards or peripherals that you removed earlier.
- 3 Replace the side panels.
- 4 Connect the necessary cables and turn on your computer.

# Opening your computer



**Caution!** Before you proceed, make sure that you have turned off your computer and all peripherals connected to it. Read the "Preinstallation instructions" on page 54.

You need to open your computer before you can install additional components. See the following section for instructions.

## To remove the side panel

- 1 Turn off your computer and unplug all cables.
- 2 Place your computer on a flat, steady surface.
- 3 Remove the four screws from the rear panel using a screwdriver. Set the screws aside.

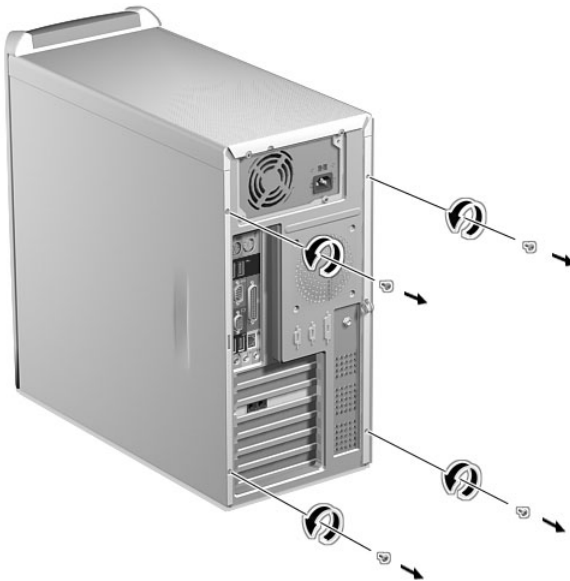

- 4 Hold one side panel with both hands. Slide it back about an inch and then gently pull it outward to detach it. Do the same to the other side.

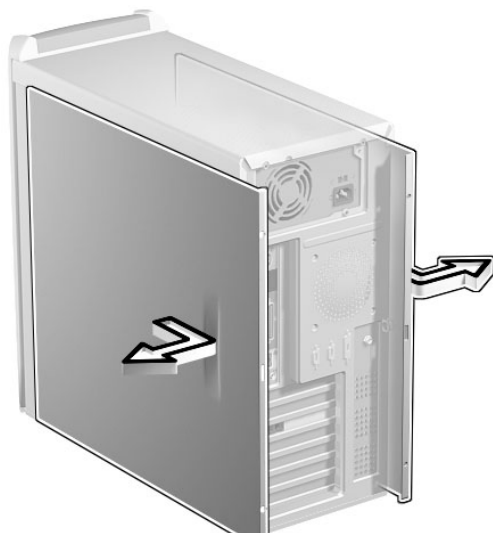

### To replace the side panel

- 1 Align the side panel's hinges to the housing frame and then push it in to slide it back into place. Do the same to the other side.

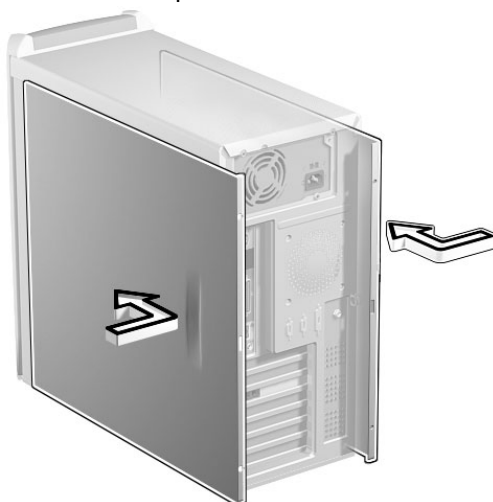

- 2 Secure the side panels with the four screws you removed earlier.





# Internal components

The figure below shows what your computer looks like once you remove the side panel:

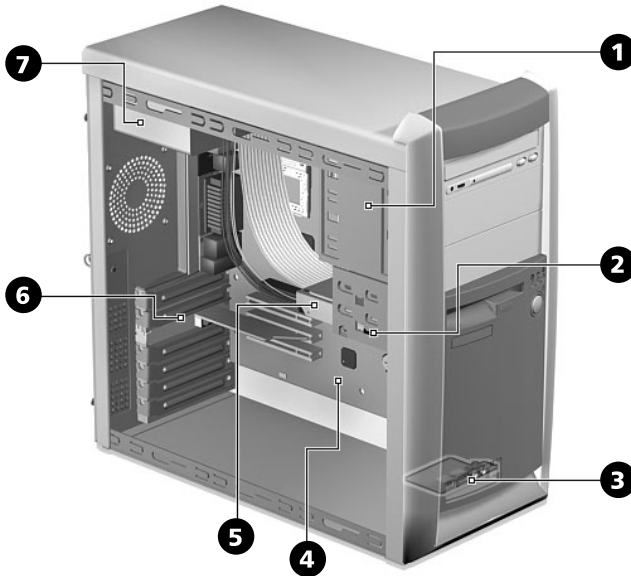

No.	Component
1	5.25-inch drive bays (three bays)
2	3.5-inch drive bays (two bays)
3	Daughterboard
4	Mainboard <small>see note</small>
5	Hard disk
6	Expansion slots
7	Power supply



**Note:** The mainboard model shown in the figure above may not be exactly the same with the one found in your computer.

# System boards

## Mainboard layout

The mainboard becomes accessible once you open your computer. Refer to the section below for the corresponding mainboard layout of your Veriton 7600 series computer model.

## Veriton 7600G mainboard layout

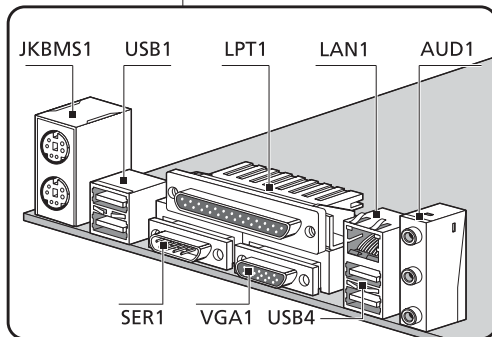
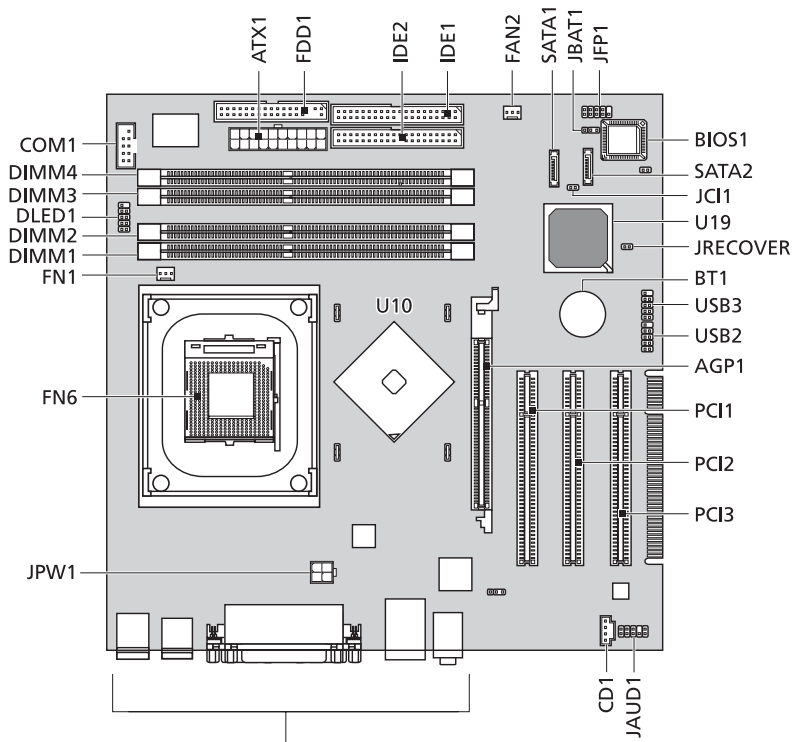

Label	Component
AGP1	AGP slot (VT7600G only) <i>see note</i>
AUD1	Line-in (top), line-out (middle), and rear microphone-in (bottom) ports
ATX1	Power connector
BIOS1	BIOS chipset
BT1	Battery
CD1	CD-in connector
COM1	Serial connector
DLED1	D-Bracket (LANScope) connector
DIMM1 DIMM2 DIMM3 DIMM4	DIMM sockets 1-4
FN1	3-pin CPU fan connector
FN6	CPU ZIF socket
FAN2	3-pin system fan connector
FDD1	FDD connector
IDE1	IDE 1 connector
IDE2	IDE 2 connector
JAUD1	Audio FPIO connector
JBAT1	1-2 Normal 2-3 Clear CMOS
JCI1	Intrusion connector

Label	Component
JFP1	HDD LED, Power LED connector Power button and Reset switch controller
JKBMS1	PS/2 mouse (upper) and keyboard (lower) ports
JPW1	Power connector (12V power)
JRECOVER	One Touch Recovery button connector
LPT1	Parallel/Printer port
PCI1 to PCI3	PCI slots 1 to 3
SATA1 SATA2	Serial HDD connectors
SER1	Serial port
U10	Northbridge
U19	Southbridge
USB1	USB ports
USB2	Front USB 2.0 connector or Unused
USB3	Front USB 2.0 connector or Unused
USB4	USB ports
VGA1	Monitor port (VT7600G only)



**Note:** For the location of the AGP slot on the Veriton 7600 mainboard, see page 59.

# Audio board

The audio board that came with your computer should look like the figure that follows.

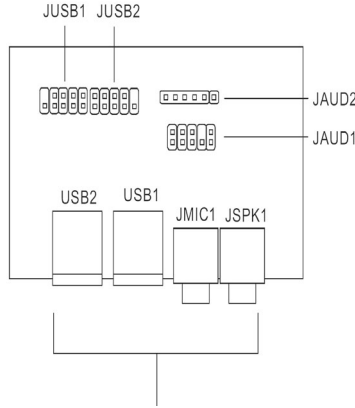

Label	Description
JUSB1	USB Connector - connects to the JUSB1 of the mainboard
JUSB2	USB Connector - unused
USB1	USB port
USB2	USB port
JAUD1	Standard audio connector - connects to the JAUD1 of the mainboard
JAUD2	Standard audio connector -unused
JMIC1	Microphone-in jack
JSPK1	Audio out port



.....

**Note:** The system has two microphone-in jacks (front and rear). However, you can not use both of them at the same time. By default, your system enables the microphone-in jack in front and disables the one at the back.

## Upgrading your computer

Certain components of your computer are upgradeable such as the memory, the hard disk, the CPU and the expansion cards. You need to observe the "Installation precautions" on page 54 when installing or removing a computer component. However, for safety purposes, we do not recommend that you perform these upgrades yourself. If you want to replace or upgrade any of these components, contact your dealer or a qualified service technician for assistance.



.....

**Note:** The mainboard model shown in the following figures may not be exactly the same with the one found in your computer.

### Installing additional memory

The four 184-pin sockets on the mainboard support Double Data Rate (DDR) Synchronous Dynamic Random Access Memory (SDRAM)-type DIMMs. You may install 128-MB, 256-MB, 512-MB or 1-GB DIMMs for a maximum memory capacity of 4 GB.

The DDR DIMMs should work under 2.5 volts. You can install PC2100/DDR266, PC2700/DDR333, or PC3200/DDR400 modules in the DDR DIMM sockets. Contact your dealer for qualified DIMM vendors.

Each DDR DIMM socket is independent from the other. This independence allows you to install DDR DIMMs with different capacities to form different configurations.

### To remove a DDR DIMM



.....

**Note:** The DDR DIMM has only one notch located on the center of the module.

- 1 Remove the side panel (see page 56).
- 2 Locate the DDR DIMM socket on the mainboard.

- 3 Press the holding clips on both sides of the DDR DIMM socket outward to release the DDR DIMM (a). Gently pull the DDR DIMM out of the socket (b).

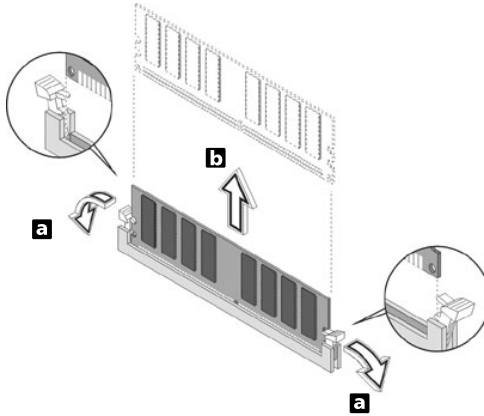

## To install a DDR DIMM

- 1 Locate the DDR DIMM socket on the mainboard.
- 2 Align the DDR DIMM with the socket (a). Press the DDR DIMM into the socket until the clips lock onto the DDR DIMM (b).

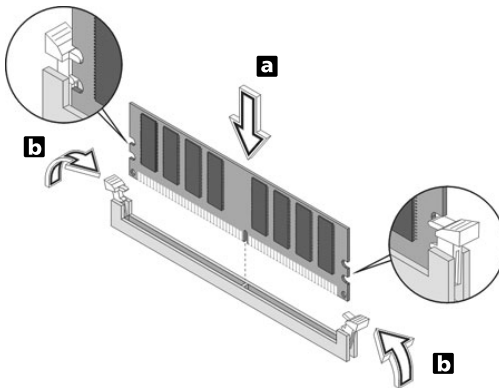

**Note:** The DDR DIMM sockets are slotted to ensure proper installation. If you insert a DDR DIMM but it does not fit easily



into the socket, you may have inserted it incorrectly. Turn the DDR DIMM around and try to insert it again.

## To reconfigure your computer

Your computer automatically detects the amount of memory installed. Run the BIOS utility to view the new value for total system memory and make a note of it.

## Replacing the hard disk

Follow these steps to replace your computer's hard disk:

- 1 Remove the side panel (see page 56).
- 2 Remove the four screws that hold the hard disk to the disk frame. Set the screws aside.

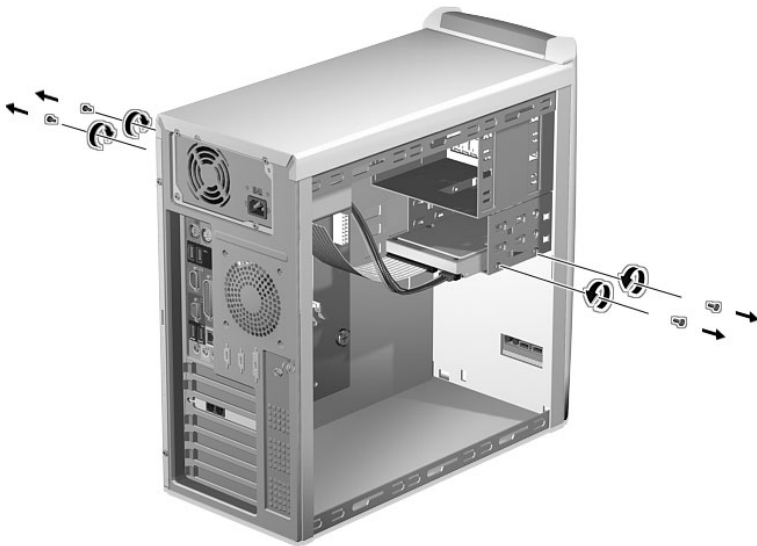

- 3 (a) Detach the power and hard disk cables from the hard disk.  
(b) Detach the hard disk from the drive frame.

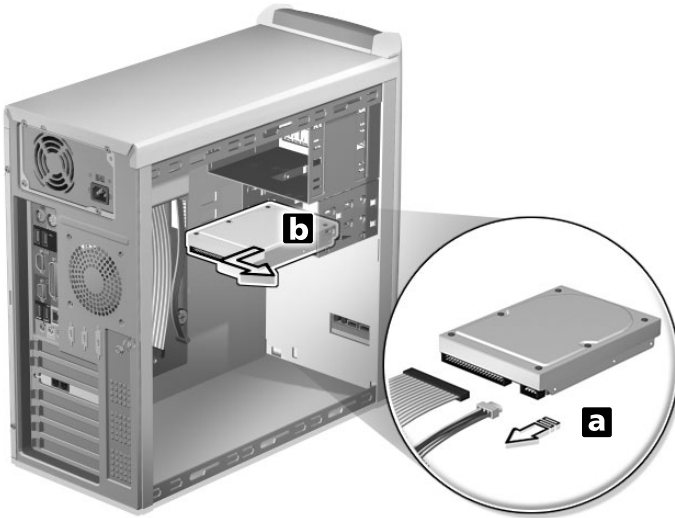

- 4 (a) Insert the new hard disk into the frame.  
(b) Connect the power and hard disk cables to the new hard disk.

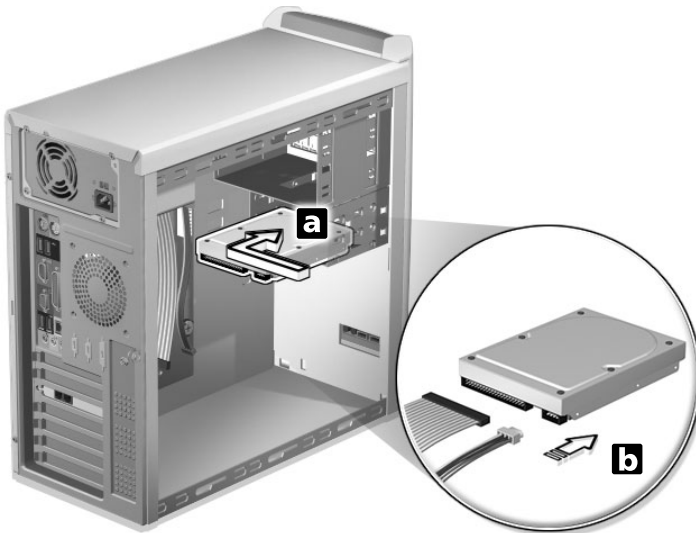

- 5 Secure it with the four screws you removed earlier.



**Note:** Make sure that the other ends of the disk cables are securely connected to their corresponding connectors on the mainboard.

- 6 Replace the side panel (see page 57).

## Installing an expansion card

To install an expansion card:

- 1 Remove the side panel (see page 56).
- 2 Locate an empty PCI slot on the mainboard.
- 3 Remove the screw that holds the bracket to the computer. Save the screw.

- 4 Pull out the bracket on the housing opposite the selected empty slot.



- 5 Remove the expansion card from its protective packaging.
- 6 Align the card with the empty bracket and then insert it into the slot. Make sure that the card is properly seated.

- 7 Secure the card to your computer with a screw you removed earlier.



- 8 Replace the side panel (see page 57).

When you turn on the computer, BIOS (Basic Input/Output System) automatically detects and assigns resources to the newly-installed devices.



# 5 System utilities





This chapter describes applications that are preinstalled on your computer.

Depending on the hardware and optional features installed in your computer, your system came bundled with several program utilities designed to streamline your computer's operations. These utilities may include any of the following:

- Acrobat® Reader™
- Acer LANScope Client Manager (optional)
- Norton AntiVirus
- NTI CD-Maker
- PowerDVD
- BIOS utility
- Acer One-Touch Recovery (System restore utility)

If your computer is configured with Microsoft Windows XP the following utilities can be used to monitor and maintain system health.

- Backup
- Disk Defragmenter

All of the applications that came with your computer are very easy to use. However, if you need more help and information, you may refer to the online help documentation provided in each software application.

# Acrobat Reader

Acrobat Reader is a software that lets you view, navigate, browse and print Adobe Portable Document Format (PDF) files on all major computer platforms.



To read a PDF document you can:

- Simply double click on any file with an icon like that shown above.  
or
- 1 On the windows taskbar, click on the Start button, highlight Programs, and select Acrobat Reader.
- 2 Once the program is running, select Open from the File menu.
- 3 Select the file you wish to view in the Open file browser and click the Open button.

For more information about Acrobat Reader, you may refer to the Acrobat Reader Help menu.

## Acer LANScope (optional)

Acer LANScope allows desktop management via the Web, standard network, or dial-up connections. It is compatible with the leading management specifications, such as Wired for Management 2.0, Desktop Management Interface (DMI) v2.0, and others.

Your computer may be bundled with a LANScope installation CD. To install LANScope:

- 1 Insert the LANScope installation CD into the optical drive.



.....

**Caution!** Make sure that the LANScope installation CD is properly inserted into the optical drive. Improper insertion may damage both the CD and the drive.

Refer to page 25 for instructions on how to insert a CD into your computer's optical drive.

- 2 Follow all onscreen instructions until installation is completed.

For more information on how to use the LANScope, you may refer to the LANScope Help menu.



.....

**Note:** Acer LANScope currently supports Windows 98, Windows Me, Windows 2000 and Windows XP platforms.

# Norton AntiVirus

Norton AntiVirus is an anti-virus software which finds and repairs infected files, protects against viruses to keep your computer data safe and secure. It also scans incoming email attachments for viruses. It provides useful virus detection and repair facilities.

## How do I check for viruses using Norton AntiVirus?

A full system scan scans all files on your computer. To perform a system scan:

- 1 Start Norton AntiVirus
  - Double click on the Norton AntiVirus Icon on the desktop
  - or
  - Click on the Start menu in the Windows taskbar, highlight Programs, and select Norton AntiVirus.
- 2 In the Norton AntiVirus main window, click Scan for Viruses.

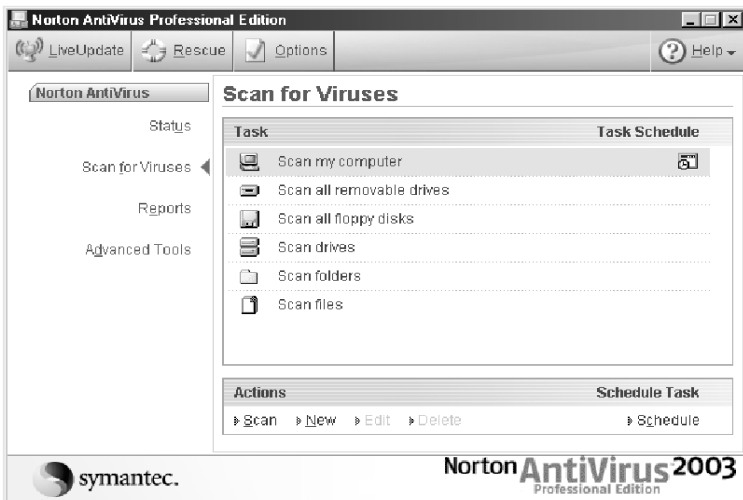

- 3 In the Scan for Viruses pane, click Scan My Computer.
- 4 Under Actions, click Scan.

When the scan is complete, a scan summary appears.

- 5 When you are done reviewing the summary, click Finished.

You can schedule customized virus scans that run unattended on specific dates and times or at periodic intervals. If you are using the computer when the scheduled scan begins, it runs in the background so that you do not have to stop working.

For more information about Norton AntiVirus, including setting up custom scans and scheduling scans, refer to the Norton AntiVirus Help menu.

# NTI CD-Maker (for models with CD-RW)

The NTI CD-Maker is a CD-Recording software which allows you to create and copy audio, data and videos to CD-R or CD-RW discs.

To copy an audio or data disc:



- 1 Click the Quick Burning icon  on the desktop.
- 2 Insert the CD you would like to copy into the source drive and a blank disc into the target drive.
- 3 Choose the source and target drives from the pull-down lists.

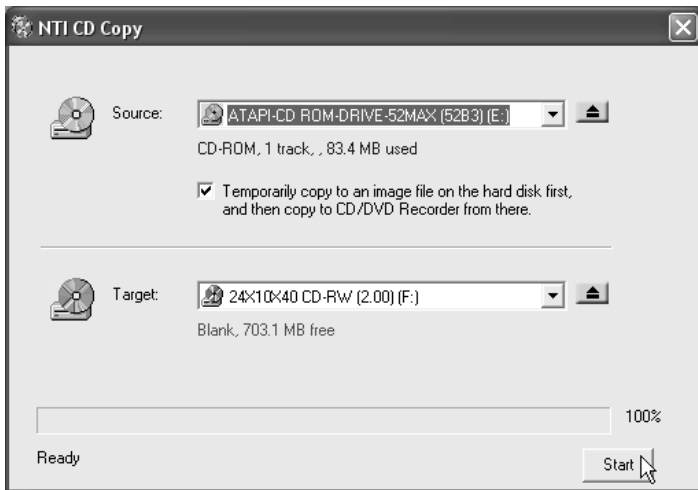

- 4 Click the Start button to begin copying.

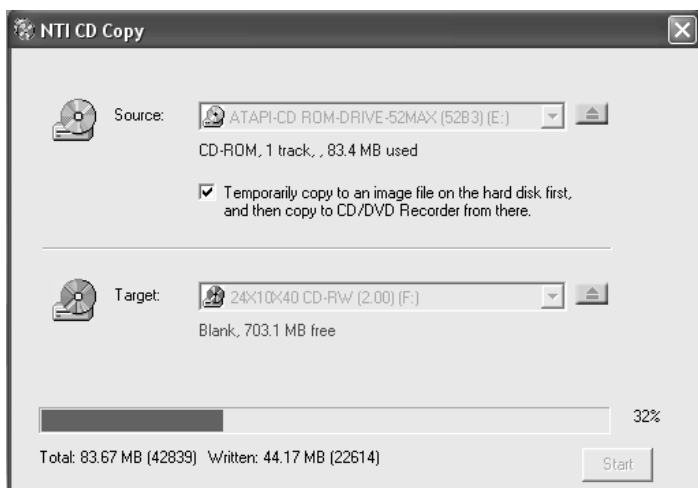

For more information about NTI CD-Maker and its other features, refer to the NTI CD-Maker Help menu.



## PowerDVD (for models with DVD)

PowerDVD is a high-quality, pure software DVD player which brings high-quality movies and karaoke to your multimedia PC. You can play back high resolution DVD titles or MPEG-2 files with MPEG-2 video and Dolby Digital (AC-3) audio. PowerDVD provides a complete set of commands for navigation and advanced features such as multi-angle switching, multi-language and multi-subtitle selection, and parental control. It also has the i-Power Internet Enabling feature, which links to online DVD resources via the Power DVD Desktop Portal Page.

### How do I open PowerDVD and watch a DVD?

In most cases, when you insert a DVD into your computer's optical drive, PowerDVD will automatically open a viewer window and the control panel and begin playing.



If PowerDVD does not open automatically:

- 1 Click the Start button in the taskbar.
- 2 Highlight All Programs
- 3 Click the Cyberlink PowerDVD tab
- 4 Select PowerDVD

When PowerDVD opens simply press the play button  to begin playback.

For more information about Cyberlink PowerDVD and its other features, refer to the PowerDVD Help menu.

# BIOS utility

The BIOS utility is a hardware configuration program built into your computer's Basic Input/Output System (BIOS). Since most computers are already properly configured and optimized, there is no need to run this utility. However, if you encounter configuration problems and get the "Run Setup" message, you will need to run this utility.



.....  
**Note:** Before you run BIOS, make sure that you have saved all open files. The computer reboots immediately after you exit Setup.

To run the BIOS utility, press the **Del** key on your keyboard during computer boot up.

# Reinstalling programs

If you uninstall one of the preinstalled programs and want to reinstall it, do the following:

- 1 Make sure that the system is turned on.
- 2 Insert the System CD into the CD or DVD drive.
- 3 Select the application that you want to reinstall.
- 4 Follow all onscreen instructions until you finish the installation.

## Recovering your system

If your operating system files are lost or damaged, the recovery process will restore your system's original factory default settings. Your Acer Veriton series computer includes a One Touch Recovery button, a feature that makes restoring your system quick and easy.

One Touch Recovery works from a hidden 2 GB partition on your hard drive that contains all the information required to restore your system.

There are two ways to initiate recovery. If your computer is not equipped with the (optional) One Touch Recover button, you can press Alt + F10 after the BIOS finishes running the Power On Self Test (POST).



.....

**Warning: Initiating the recovery operation while the operating system is running will result in abnormal shutdown and may make your current OS unstable or unusable.**

After the POST runs, you have only 1.5 seconds to press Alt + F10. Follow all onscreen instructions.

You can also follow the steps below:

- 1 Locate the (optional) One touch recovery button. See the image on page 12.

- 2 Press the button. After a moment the following screen will appear on your display.

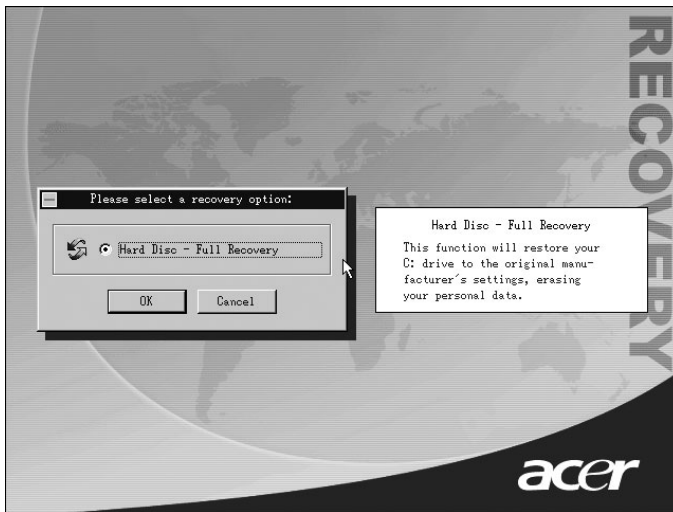

- 3 Click OK. You will be prompted again to continue.



- 4 Click OK again.



- 5 After 15 seconds the system will reboot and initiate the restore operation.

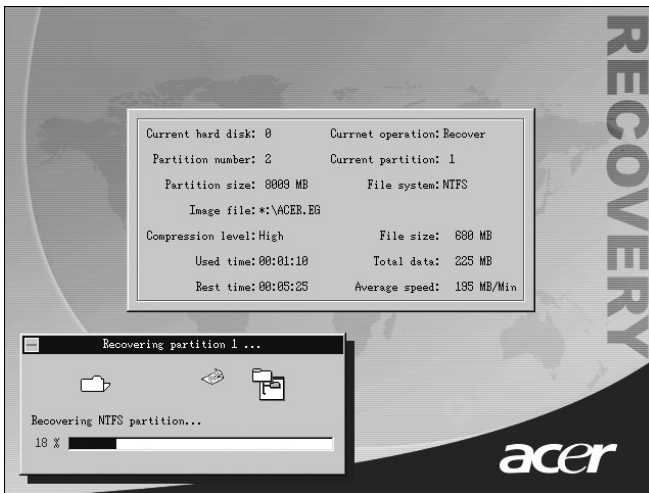

- 6 After the recovery operation finishes the system will reboot again. You will be required to go through the setup process again.



-----  
**Caution!** Running the Recovery operation will erase all files previously saved in your computer so make sure to back up your important files before starting the recovery process.

If you attempt to restore your system using the One Touch feature, and the system DOES NOT respond, contact your local vendor or authorised Acer representative immediately.

# Using Backup (Windows XP only)

The Backup utility creates copies of information on your hard disk. In the event that the original data on your hard disk is erased or overwritten, or becomes inaccessible because of a hard disk malfunction, you can use the copy to restore your lost or damaged data.

## How do I back up files from my hard drive?

To run the Backup utility:

- 1 Click the Start button in the taskbar.
- 2 Highlight All Programs
- 3 Click Accessories
- 4 Select System Tools
- 5 Click Backup

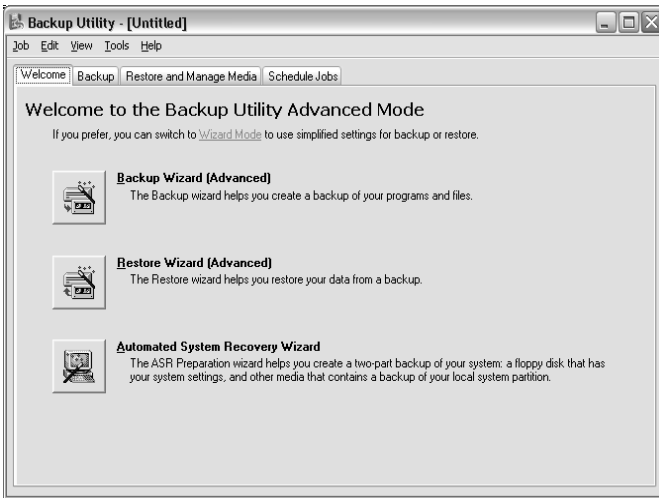

When Backup starts, follow the onscreen instructions to set up your backup profile and schedule.

For more information about Backup, refer to Windows XP help.



# Disk Defragmenter (Windows XP only)

The disk defragmentation utility consolidates files and folders on your computer's hard disk. This allows your computer to access files and folders and save new data more efficiently. By consolidating your files and folders, the defragmenter also consolidates the volume's free space, making it less likely that new files will be fragmented.

## How do I defragment my hard drive?

To run the Disk Defragmenter:

- 1 Click the Start button in the taskbar.
- 2 Highlight All Programs
- 3 Click Accessories
- 4 Select System Tools
- 5 Click Disk Defragmenter

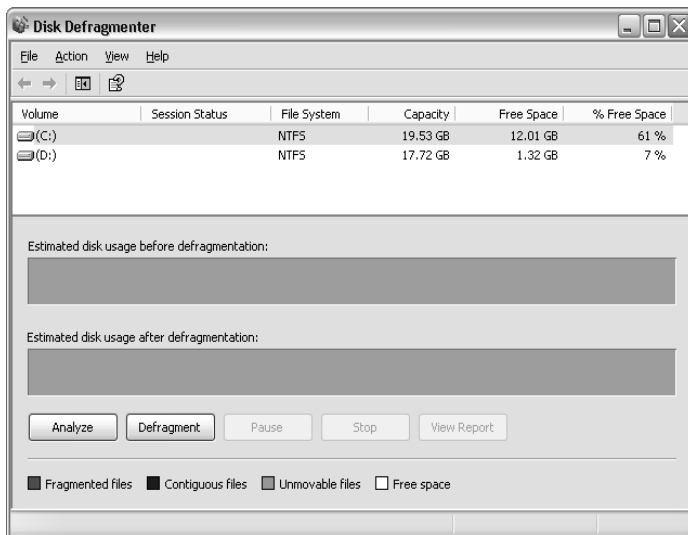

When Disk Defragmenter opens, select a drive/volume and click Analyze. The system will quickly examine the volume and determine whether it needs to be defragmented or not.

For more information about Disk Defragmenter, refer to Windows XP help.



## 6 Frequently asked questions



This chapter tells you what to do in case your computer is not working properly. However, if a more serious problem arises, contact your dealer or the technical support center ([www.acersupport.com](http://www.acersupport.com)) for assistance.

# Frequently asked questions

The following questions are possible situations that may arise during the use of your computer and each is followed by easy answers and solutions to the situation.

**Q:** I pressed the power switch but the system did not boot up.

**A:** Check the LED located above the power switch.

If the LED is not lit, no power is being applied to the system. Do any of the following:

- Check if the voltage selector switch located on the rear panel of the computer is set to the correct voltage.
- Check if you plugged the power cable properly into an electrical outlet.
- If you are using a power strip or AVR, make sure that it is plugged in and turned on.

If the LED is lit, check the following:

- Is a nonbootable (nonsystem) diskette in the floppy drive? If yes, remove or replace it with a system diskette and press **Ctrl + Alt + Del** to restart your computer.
- The operating system files may be damaged or missing. Insert the startup disk you created during Windows setup into the floppy drive and press **Ctrl + Alt + Del** to restart your computer. This will automatically diagnose your system and make necessary fixes. However, if the diagnostic utility still reports a problem, then you may have to perform the recovery process to restore your system to its original default factory settings.



.....  
**Note:** For more information about recovering your system, refer to page 86.

**Q:** Nothing appears on the screen.

**A:** Your computer's power management function automatically blanks the screen to save power. Just press any key to turn the display back on.

If pressing a key does not work, you can restart your computer. If restarting your computer does not work, contact your dealer or the technical support center for assistance.

**Q:** The printer does not work.

**A:** Do the following:

- Make sure that the printer is connected to a power outlet and that it is turned on.
- Make sure that the printer cable is connected securely to the system's parallel port and the corresponding port on the printer. See "Connecting your printer" on page 43 for information on how to connect the printer to your computer.
- For additional information concerning the printer, refer to the printer's documentation.

**Q:** No sound comes out from the computer.

**A:** Check the following:

- The volume may be muted. Look for the Volume icon on the taskbar. If it is crossed-out, click on the icon and deselect the **Mute** option. You can also press the volume control/mute knob on your USB keyboard to toggle from mute to sound on.
- If headphones, earphones, or external speakers are connected to the line-out jack of your computer, the internal or built-in speakers are automatically turned off.

**Q:** System cannot read diskette, hard disk, CD or DVD information.

**A:** Check the following:

- Make sure that you are using the correct type of disc. See page 25.
- Make sure the CD or DVD is inserted into the drive correctly.
- Check if the CD or DVD is clean and not scratched.
- Check your drive by using a good (i.e., undamaged) disc. If your drive can not read the information on the good disc there may be a problem with the drive. Contact your dealer or technical support center for assistance.

**Q:** System cannot write data on the hard disk or CD-R/CD-RW.

**A:** Check the following:

- Make sure the diskette or hard disk is not write-protected. Refer to the Optical drive section on page 25.
- Make sure that you are using the correct type of disc or diskette. Refer to the Optical drive section on page 25.



# Appendix A: Notices

## FCC notice

This device has been tested and found to comply with the limits for a Class B digital device pursuant to Part 15 of the FCC Rules. These limits are designed to provide reasonable protection against harmful interference in a residential installation. This device generates, uses, and can radiate radio frequency energy and, if not installed and used in accordance with the instructions, may cause harmful interference to radio communications.

However, there is no guarantee that interference will not occur in a particular installation. If this device does cause harmful interference to radio or television reception, which can be determined by turning the device off and on, the user is encouraged to try to correct the interference by one or more of the following measures:

- Reorient or relocate the receiving antenna
- Increase the separation between the device and receiver
- Connect the device into an outlet on a circuit different from that to which the receiver is connected
- Consult the dealer or an experienced radio/television technician for help

### **Notice: Shielded cables**

All connections to other computing devices must be made using shielded cables to maintain compliance with FCC regulations.

### **Notice: Peripheral devices**

Only peripherals (input/output devices, terminals, printers, etc.) certified to comply with the Class B limits may be attached to this equipment. Operation with noncertified peripherals is likely to result in interference to radio and TV reception.



**Caution!** Changes or modifications not expressly approved by the manufacturer could void the user's authority, which is granted by the Federal Communications Commission, to operate this computer.

**Use conditions**

This part complies with Part 15 of the FCC Rules. Operation is subject to the following two conditions: (1) this device may not cause harmful interference, and (2) this device must accept any interference received, including interference that may cause undesired operation.

**Notice: Canadian users**

This Class B digital apparatus meets all requirements of the Canadian Interference-Causing Equipment Regulations.

**Remarque à l'intention des utilisateurs canadiens**

Cet appareil numérique de la classe B respecte toutes les exigences du Règlement sur le matériel brouilleur du Canada.

## Important safety instructions

Read these instructions carefully. Save these instructions for future reference.

1. Follow all warnings and instructions marked on the product.
2. Unplug this product from the wall outlet before cleaning. Do not use liquid cleaners or aerosol cleaners. Use a damp cloth for cleaning.
3. Do not use this product near water.
4. Do not place this product on an unstable cart, stand, or table. The product may fall, causing serious damage to the product.
5. Slots and openings in the housing and the back or bottom are provided for ventilation; to ensure reliable operation of the product and to protect it from overheating, these openings must not be blocked or covered. The openings should never be blocked by placing the product on a bed, sofa, rug, or other similar surface. This product should never be placed near or over a radiator or heat register, or in a built-in installation unless proper ventilation is provided.
6. This product should be operated from the type of power indicated on the marking label. If you are not sure of the type of power available, consult your dealer or local power company.
7. Do not allow anything to rest on the power cord. Do not locate this product where persons will walk on the cord.
8. If an extension cord is used with this product, make sure that the total ampere rating of the equipment plugged into the extension cord does not exceed the extension cord ampere rating. Also,

- make sure that the total rating of all products plugged into the wall outlet does not exceed the fuse rating.
9. Never push objects of any kind into this product through cabinet slots as they may touch dangerous voltage points or short out parts that could result in a fire or electric shock. Never spill liquid of any kind on the product.
  10. Do not attempt to service this product yourself, as opening or removing covers may expose you to dangerous voltage points or other risks. Refer all servicing to qualified service personnel.
  11. Unplug this product from the wall outlet and refer servicing to qualified service personnel under the following conditions:
    - a When the power cord or plug is damaged or frayed
    - b If liquid has been spilled into the product
    - c If the product has been exposed to rain or water
    - d If the product does not operate normally when the operating instructions are followed. Adjust only those controls that are covered by the operating instructions since improper adjustment of other controls may result in damage and will often require extensive work by a qualified technician to restore the product to normal condition.
    - e If the product has been dropped or the cabinet has been damaged
    - f If the product exhibits a distinct change in performance, indicating a need for service.
  12. Replace the battery with the same type as the product's battery we recommend. Use of another battery may present a risk of fire or explosion. Refer battery replacement to a qualified serviceman.
  13. **Warning!** Batteries may explode if not handled properly. Do not disassemble or dispose of them in fire. Keep them away from children and dispose of used batteries promptly.
  14. Use only the proper type of power supply cord set (provided in your accessories box) for this unit. It should be a detachable type: UL listed/CSA certified, type SVT, rated 7A 125V minimum, VDE approved or its equivalent. Maximum length is 15 feet (4.6 meters).

## Laser compliance statement

The CD or DVD drive in this computer is a laser product. The CD or DVD drive's classification label (shown below) is located on the drive.

**CLASS 1 LASER PRODUCT**

**CAUTION:** INVISIBLE LASER RADIATION WHEN OPEN. AVOID EXPOSURE TO BEAM.

## Lithium battery statement

### **CAUTION**

Danger of explosion if battery is incorrectly replaced. Replace only with the same or equivalent type recommended by the manufacturer. Discard used batteries according to the manufacturer's instructions.

## Macrovision<sup>®</sup> statement

This product incorporates copyright protection technology that is protected by method claims of certain U.S. patents and other intellectual property rights owned by Macrovision Corporation and other rights owners. Use of this copyright protection technology must be authorized by Macrovision Corporation, and is intended for home and other limited viewing uses only unless otherwise authorized by Macrovision Corporation. Reverse engineering or disassembly is prohibited.

## Year 2000 compliance statement

Your computer carries the "Hardware NSTL Tested Year 2000 Compliant" logo, which certifies that this model has been tested by NSTL using the YMark2000 test, and has been found to meet NSTL's standards for Year 2000 hardware compliance.





Appendix B:

# Taking care of your computer

Please read the important instructions listed in this section. Following these instructions will help you maximize the durability of your computer.

## Important tips

- Do not expose the computer to direct sunlight. Do not place it near sources of heat, such as a radiator.
- Do not expose the computer to temperatures below 0°C (32°F), or above 50°C (122°F).
- Do not subject the computer to magnetic fields.
- Do not expose the computer to rain or moisture.
- Do not spill water on the computer.
- Do not subject the computer to heavy shock or vibration.
- Do not expose the computer to dust and dirt.
- Never place the system on uneven surfaces.
- Do not step on the power cord or place heavy objects on top of it. Carefully route the power cord and any cables away from personal traffic.
- When unplugging the power cord, do not pull on the cord itself but pull on the plug.
- The total ampere rating of the equipment plugged in should not exceed the ampere rating of the cord if you are using an extension cord. Also, the total current rating of all equipment plugged into a single wall outlet should not exceed the fuse rating.
- Check the documentation that came with your software programs to see if you can select other combinations of resolution and color. These adjustments could make viewing the screen more comfortable.

## Cleaning and servicing

### To clean your computer and keyboard

- 1 Turn off the computer and unplug the power cord.



- 2 Use a soft cloth moistened with water and gently wipe the exterior of the computer and the keyboard. Do not use liquid or aerosol cleaners.

## To clean your pointing device

### To clean a regular mouse (with rubber ball)

- 1 Open the circular cover underneath the mouse.
- 2 Take out the rubber ball and wipe it with a soft, damp cloth.
- 3 Put the ball back and close the cover.

### To clean an optical mouse

For users of an optical mouse, refer to the documentation that came with your mouse for maintenance instructions.

## To clean your monitor

Make sure that you keep your screen clean. For cleaning instructions, refer to the documentation that came with your monitor.

## When to contact a service technician

- If you dropped and damaged the computer
- If liquid has been spilled into the computer
- If the computer is not operating normally
- If a computer problem persists even after you have checked and done the troubleshooting tips discussed in the “Frequently-asked questions” section on page 96
- If your problem is not listed in the “Frequently-asked questions” section on page 96
- If you want to replace or upgrade any of your computer’s internal components

## Asking for technical assistance

For technical assistance, contact your local dealer or distributor. You may also access the Web site ([www.acersupport.com](http://www.acersupport.com)) for information on how and where to contact the service centers available in your area.



# Index

## A

accessing the online guide 6  
applications 76

## B

BIOS utility 84

## C

computer maintenance 106  
    cleaning 106  
    servicing 106  
connecting options  
    multimedia devices 46  
        audio line-in device 48  
        earphones/headphones 47  
        external speakers 46  
        microphone 46  
    network 43, 45  
    printer 43  
    serial mouse 45  
    USB devices 49

## D

disk drives  
    CD-ROM/DVD-ROM/CD-RW drive  
        inserting CDs/DVDs 25  
        taking care CDs/DVDs 26  
    hard disk 28

## F

features 10  
    connectivity 10  
    multimedia 10  
    performance 10  
Frequently-asked questions 96  
    blank screen 97  
    no audio 97  
    no sound 97  
    printer not working 97  
    system cannot read disk 98  
    system cannot write to disk 98  
    system did not boot up 96  
front panel 12

## I

internal components 59  
internet/suspend key  
    email 18  
    suspend 18  
    web browser 18

## K

keyboard 16  
    application key 23

## L

lock keys  
    Caps Lock 21  
    Num Lock 21  
    Scroll Lock 21

## M

mainboard  
    Veriton 7600 61  
multimedia key  
    forward 19  
    play/pause 19  
    stop 19

## N

NTI 81

## P

PowerDVD 83

## R

rear panel 14  
recovering your system 86  
remove the side panel 56

## S

safety instructions 101  
setting up computer 32, 35  
    area 32  
    chair 32  
    connecting peripherals  
        external monitor 39  
        power cable 40  
        USB mouse 35  
    keyboard 33  
    monitor 33  
    mouse 34  
software 76  
    Norton AntiVirus 79

- system boards 60
  - audio board 64
  - mainboard 60, 61
- system utilities
  - Acrobat Reader 77
  - Norton AntiVirus 79
  - NTI CD-Maker 81
  - PowerDVD 83
  - reinstalling programs 85

**T**

- turning off computer 42
  - software shutdown 42
  - suspend mode 42
- turning on computer 41
  - power button 41

**U**

- upgrade
  - add memory 65
    - install DDR DIMM 66
    - reconfigure computer 67
  - computer 65
  - installation precautions 54
    - ESD 54
    - post-installation 55
    - preinstallation 54
  - open computer
    - reinstall side panel 57
    - remove side panel 56
  - replace components
    - memory 65

**V**

- Veriton 7600 mainboard layout 61